



VOLT® Line Voltage Landscape Lighting 120V LED Flood Lights - VFL-4010-MS-LI-ABZ

Product Description

Introducing VOLT's new, motion sensor line of 120V LED flood lights; made from die-cast aluminum with stainless steel screws, each of the high powered flood lights features a motion sensor for security lighting applications. Integrated LED has a very wide 120° beam angle to ensure bright; alarming, light if the motion sensor is tripped. Features a yoke mount and tempered glass lens that is fully gasketed in order to provide a tight fit against moisture.

Dimensions

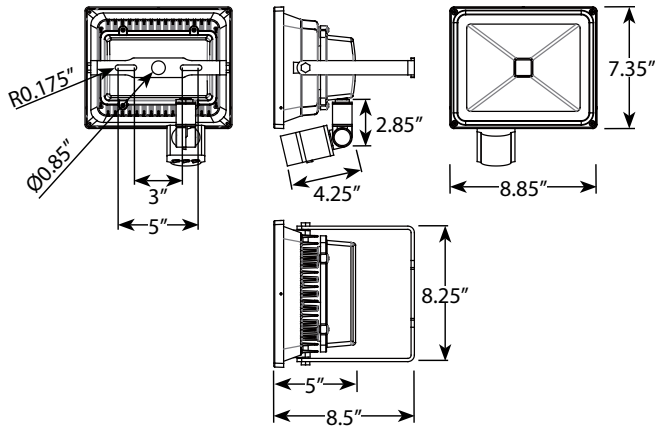

Features & Benefits

- ▶ Powder coated, die cast aluminum design with stainless steel hardware create a durable design.
- ▶ Tempered glass lens is fully gasketed, to provide a tight fit against moisture.
- ▶ Motion Sensor attached to aid in security purposes.



Specifications

- ▶ **Construction:** Aluminum housing with stainless steel screws
- ▶ **Finish:** Bronze
- ▶ **Lead Wire:** 18 AWG
- ▶ **Mounting:** Yoke Mount. Mounting canopy available separately.
- ▶ **Light Source:** Integrated LED
- ▶ **Beam Angle:** 120°
- ▶ **Operating Voltage:** 120VAC
- ▶ **Color Temperature:** 4000K
- ▶ **Lifetime:** 40,000 hours
- ▶ **Lumens:** 3,600
- ▶ **Watts:** 30W

Warranty

5 Year Warranty